



2016-V1.0-0720

Specifications

LED Power Supplies for Outdoor Use

LGSU-185C Series, 185W

PAIRUI ELECTRONICS

No. 545 Museum Road
Yangzhou, Jiangsu
China 225009

Tel: 86 (514) 8279 1592

Fax: 86 (514) 8769 3159

2016

LED Power Supplies for Outdoor Use

LGSU-185C SERIES, 185WATT, IP67 RATING

Features

- 5 Year Warranty
- Universal Input Voltage Range: 90~305Vac
- Constant Current Output Mode
- High PF up to 0.99
- Rating IP67, Suitable for Outdoor Applications
- All Round Protections: Short Circuit, Over Voltage, Over Current, Over Temperature
- Optional Dimming(0-10V, PWM, Resistor)



Applications

- ✓ Street Light
- ✓ Tunnel Light
- ✓ Flood Light
- ✓ Refrigeration Equipment
- ✓ Other Light Fixtures for Outdoor Use

Electrical

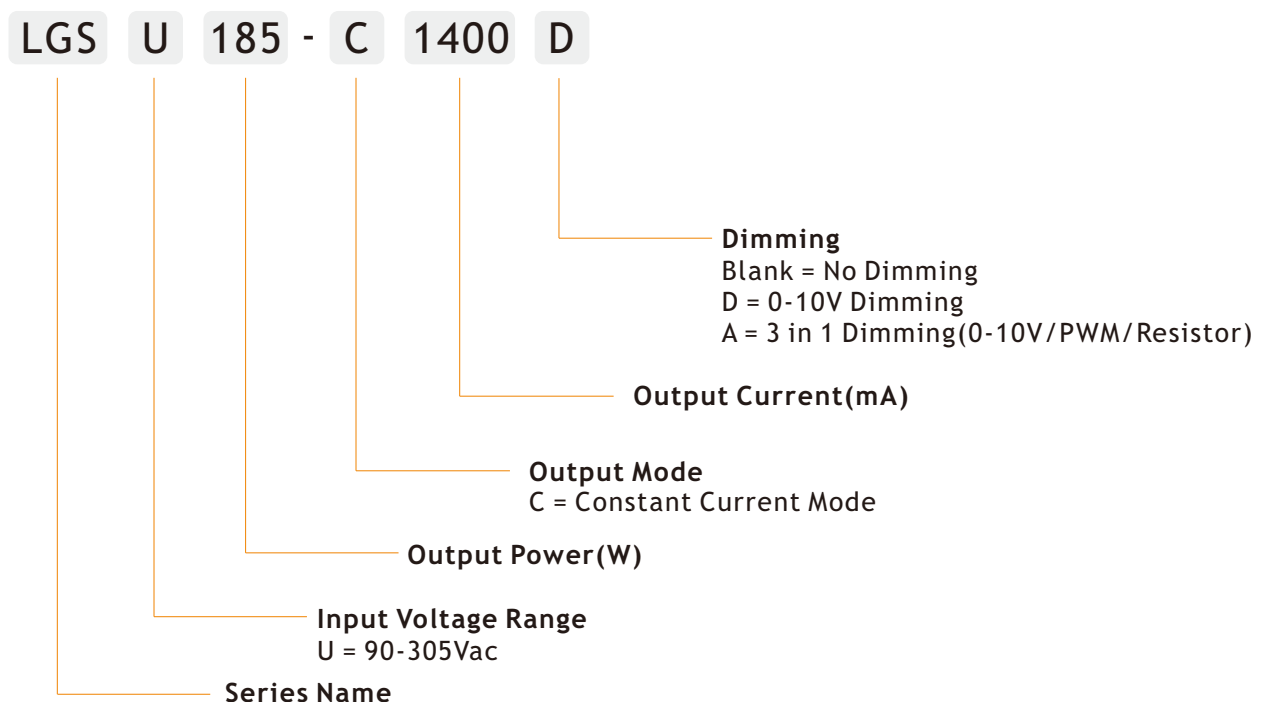

Electrical

Part Number	Nominal Input Voltage	Output Current Output Voltage	No Load Output Voltage	Ripple	Efficiency	Certificate
LGSU185-C1050	100-277VAC	1050mA(140-176V)	194V	5%	93%	CE
LGSU185-C1400	100-277VAC	1400mA(105-132V)	145V	5%	93%	CE
LGSU185-C1750	100-277VAC	1750mA(84-106V)	117V	5%	93%	CE
LGSU185-C2100	100-277VAC	2100mA(70-88V)	97V	5%	93%	CE
LGSU185-C2450	100-277VAC	2450mA(60-76V)	84V	5%	93%	CE
LGSU185-C2800	100-277VAC	2800mA(52-66V)	73V	5%	92.5%	CE
LGSU185-C3150	100-277VAC	3150mA(47-59V)	65V	5%	92.5%	CE
LGSU185-C3500	100-277VAC	3500mA(42-53V)	58V	5%	92%	CE
LGSU185-C4200	100-277VAC	4200mA(35-44V)	48V	5%	92%	CE

NOTE:

1. Other output models are may available on request;
2. Add suffix "D" for 0-10V dimming, and "A" for 3 in 1 dimming.

INPUT

PARAMETER	CONDITIONS	MIN	TYP	MAX	UNITS
Input voltage		90		305	Vac
Input frequency		47		63	Hz
Input current	Full load, Vin=110Vac Full load, Vin=220Vac		1.86 0.93		A A
Inrush current	Cold start, Vin=230Vac			65	A
Power factor(PF)	Full load, Vin=110Vac Full load, Vin=220Vac		0.99 0.96		
Leakage current	Vin=230Vac, 50Hz		0.75		mA
Surge voltage	L-N L, N-FG		4 6		KV KV

OUTPUT

PARAMETER	CONDITIONS	MIN	TYP	MAX	UNITS
Output current accuracy			5		%
Line regulation	Vin from 100Vac to 277Vac			1	%
Load regulation	Vout from min. to max.			3	%
Output current overshoot	Turning on			10	%
Turn-on delay time	Cold start, power on		1		S
Ripple	Please refer to below measurement method		5%Io		mAp-p
THD	Output load≥50%			20	%

NOTE: The values are measured at 20MHz of bandwidth by using a 12'' twisted pair-wire terminated with 0.1uF & 47uF parallel capacitor under ambient temperature 25°C at rated input voltage and rated load.

Protection

Short circuit	In hiccup mode, it will recover automatically after fault condition is removed
Over voltage	110-150% Vout, the driver shall return to normal operation after the power is turn-on again
Over current	In hiccup mode, it will recover automatically after fault condition is removed
Over temperature	In hiccup mode, it will recover automatically after fault condition is removed

Environment

PARAMETER	CONDITIONS	MIN	TYP	MAX	UNITS
Ambient operating temperature	Startup at rated voltage	-35		+70	°C
Operating relative humidity	Non condensing	10		95	%
Storage temperature	Humidity 5 ~ 100% RH	-40		+85	°C
Maximum case temperature	Hot-spot on case			+90	°C
MTBF	Full load, 220Vac input, 25°C ambient temperature	200			Khrs
Waterproof rating	IP67				
Dimension(LxWxH)	226.0 x 67.5 x 39.7mm				
Weight	1000g				

Safety/EMC

Safety	Design refer to UL8750, UL935, UL1012, UL1310 Class 2, EN61347, EN61347-2-13
EMC	Compliance to EN55015, FCC Part 15 Class B, EN61000-3-2, EN61000-3-3, EN61000-4-2, 3, 4, 6, 8, 11, EN61547

NOTE: Unless otherwise specified, all the above parameters are measured at ambient temperature of 25°C and Vin=100Vac to 277Vac.

Mechanical

No Dimming

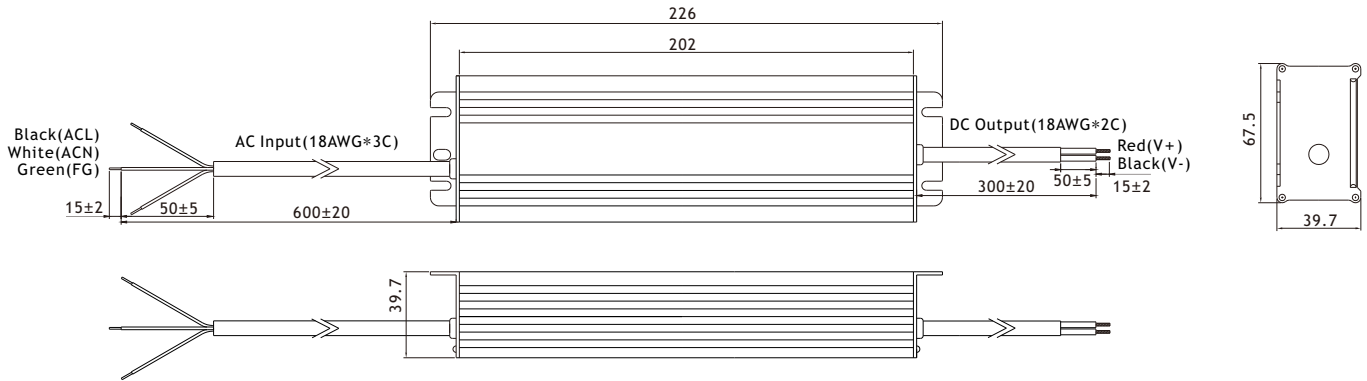

0-10V Dimming/3 in 1 Dimming

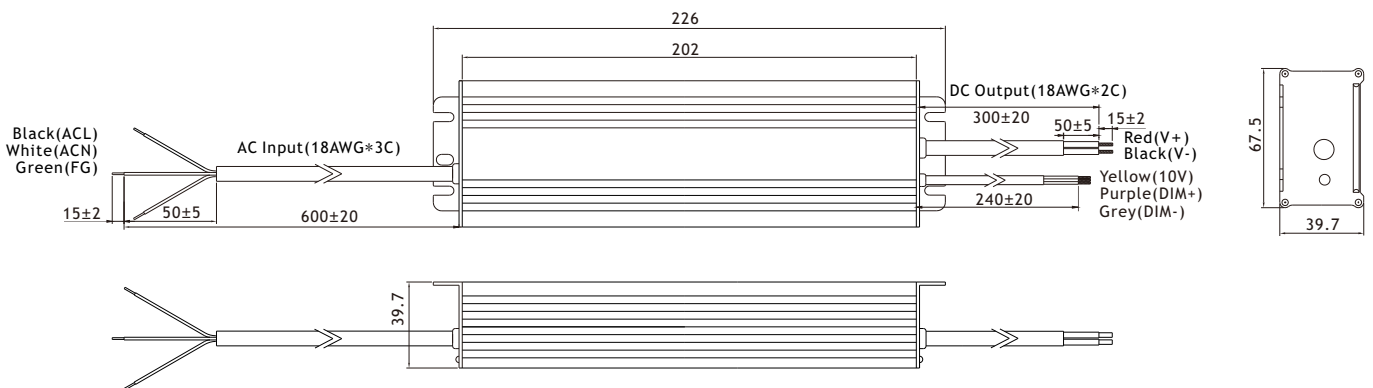

Electrical Curve

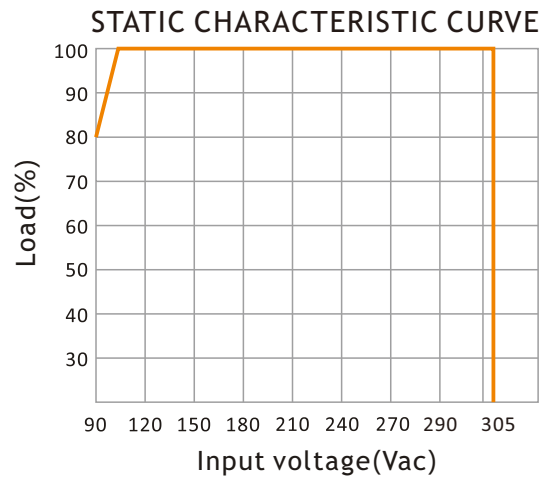
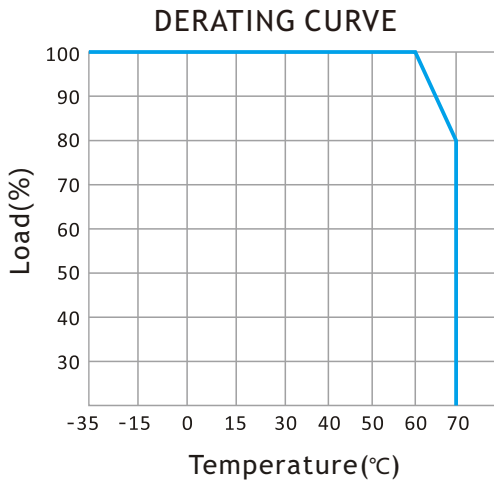

Dimming Function

0-10V Dimming

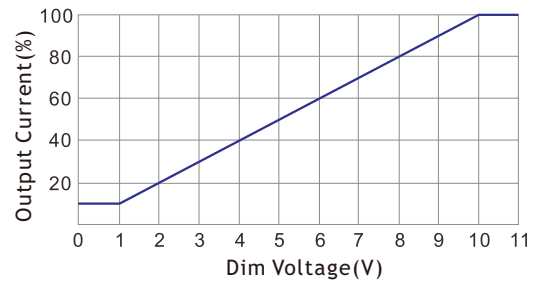
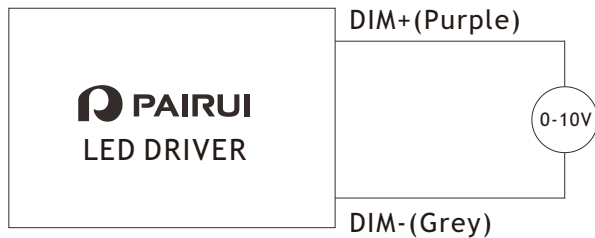

External Resistor Dimming

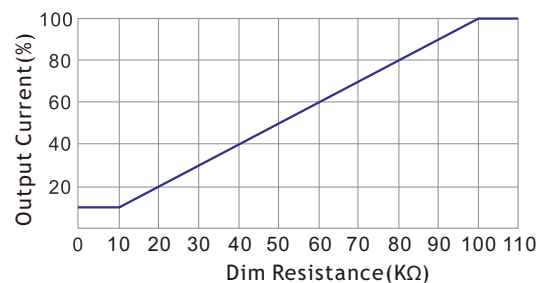
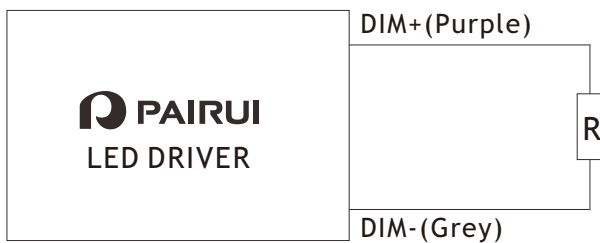

Dimming Function

PWM Dimming

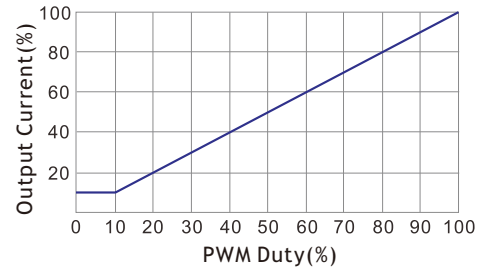
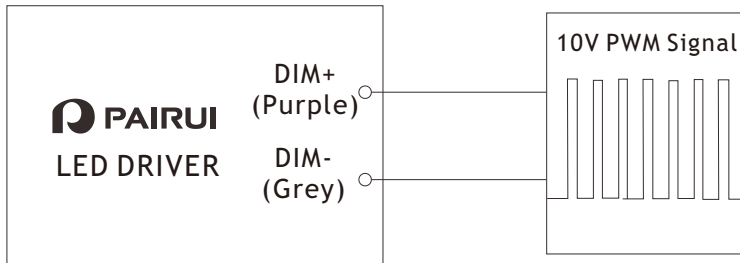

Package

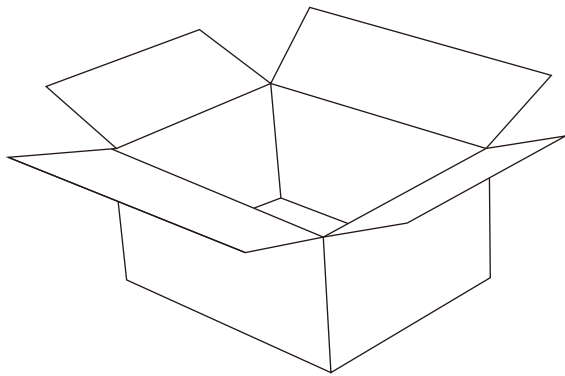

Outer Carton
L 620 x W 260 x H 185mm

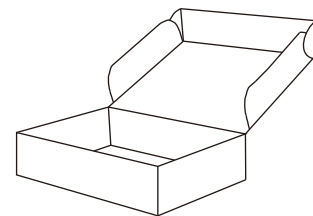

Inner Box
L 265 x W 102.5 x H 46mm





SERIES	QTY/BOX	QTY/CARTON	NET WEIGHT	GROSS WEIGHT	VOLUME
LGSU-185C	1 piece	12 boxes	12kg/carton	13kg/carton	0.03CBM/carton

Labelling

INPUT • ACL (BLK) • ACN (WHT) • ⊕ (GRN)	 PAIRUI LGSU185-C1400 LED POWER SUPPLY INPUT: 100-277VAC, 50/60Hz OUTPUT: 1400mA, 105-132VDC	• ta 70°C • tc 90°C   IP67  	OUTPUT DC+ (RED) • DC- (BLK) •

INPUT • ACL (BLK) • ACN (WHT) • ⊕ (GRN)	 PAIRUI LGSU185-C1400D LED POWER SUPPLY INPUT: 100-277VAC, 50/60Hz OUTPUT: 1400mA, 105-132VDC	• ta 70°C • tc 90°C   IP67 (0-10V Dimming)  	OUTPUT DC+ (RED) • DC- (BLK) • 10V (YEL) • DIM+ (PPL) • DIM- (GRY) •

INPUT • ACL (BLK) • ACN (WHT) • ⊕ (GRN)	 PAIRUI LGSU185-C1400A LED POWER SUPPLY INPUT: 100-277VAC, 50/60Hz OUTPUT: 1400mA, 105-132VDC	• ta 70°C • tc 90°C   IP67 (3 in 1 Dimming)  	OUTPUT DC+ (RED) • DC- (BLK) • 10V (YEL) • DIM+ (PPL) • DIM- (GRY) •

Symbol	Description
	Short-circuit-proof with safety insulation
	Independent Operation
IP67	Type of protection(IP67 for indoor and outdoor use)
	RoHS Mark
	CE Mark