



2016-V1.0-0720

Specifications

LED Power Supplies for Outdoor Use

LGU-40C Series, 40W

PAIRUI ELECTRONICS

No. 545 Museum Road
Yangzhou, Jiangsu
China 225009

Tel: 86 (514) 8279 1592

Fax: 86 (514) 8769 3159

2016

LED Power Supplies for Outdoor Use

LGU-40C SERIES, 40WATT, IP67 RATING

Features

- 5 Year Warranty
- Universal Input Voltage Range: 90~305Vac
- Constant Current Output Mode
- High PF up to 0.99
- Rating IP67, Suitable for Outdoor Applications
- All Round Protections: Short Circuit, Over Voltage, Over Current, Over Temperature
- Optional Dimming(0-10V, PWM, Resistor)



Applications

- ✓ Street Light
- ✓ Tunnel Light
- ✓ Flood Light
- ✓ Refrigeration Equipment
- ✓ Other Light Fixtures for Outdoor Use

Electrical

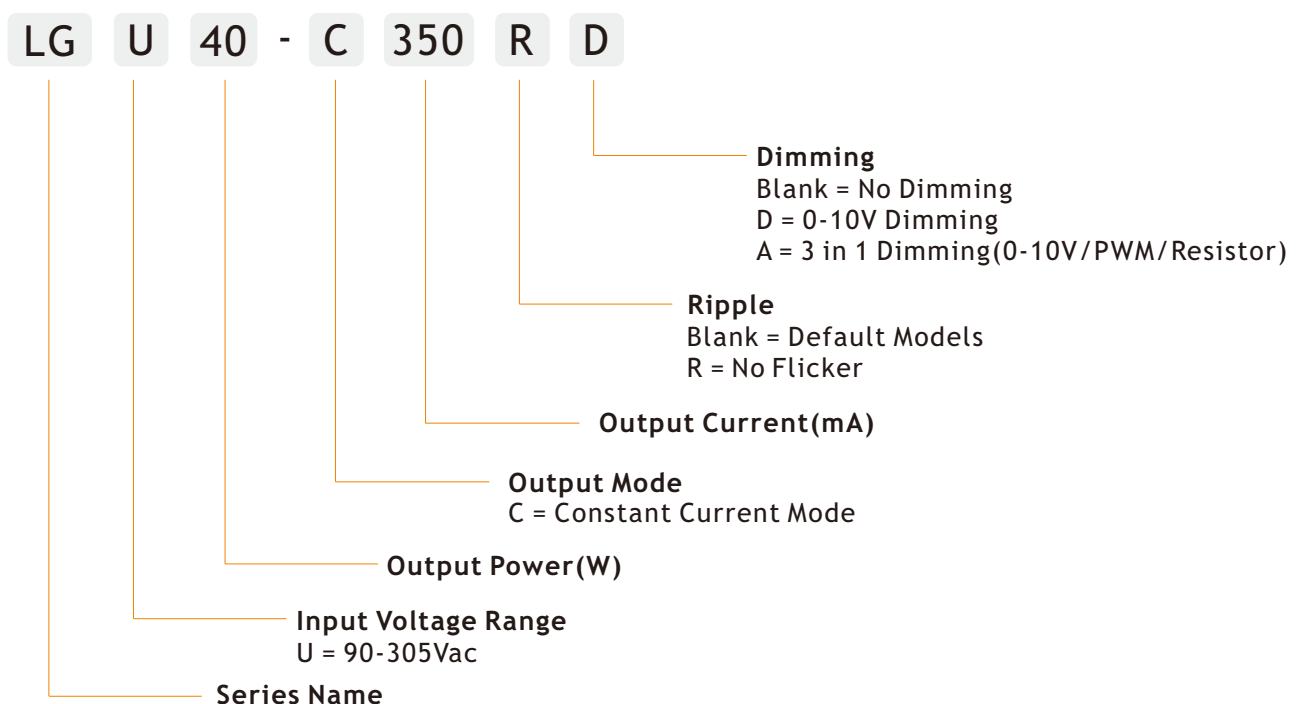

Electrical

Part Number	Nominal Input Range	Output Current Output Voltage	No Load Output Voltage	Ripple	Efficiency	Certificate
LGU40-C350	100-277Vac	350mA(80-114Vdc)	125Vdc	5%/50%	89%	CE, UL, CCC
LGU40-C450	100-277Vac	450mA(63-89Vdc)	98Vdc	5%/50%	89%	CE, UL, CCC
LGU40-C700	100-277Vac	700mA(40-57Vdc)	63Vdc	5%/50%	88%	CE, UL, CCC
LGU40-C1050	100-277Vac	1050mA(27-38Vdc)	45Vdc	5%/50%	88%	CE, UL, CCC
LGU40-C1280	100-277Vac	1280mA(22-31Vdc)	38Vdc	5%/50%	87%	CE, UL, CCC
LGU40-C1400	100-277Vac	1400mA(21-29Vdc)	35Vdc	5%/50%	86%	CE, UL, CCC
LGU40-C1660	100-277Vac	1660mA(17-24Vdc)	31Vdc	5%/50%	86%	CE, UL, CCC

NOTE:

1. Other output models are may available on request;
2. Add suffix "R" for No Flicker Low Ripple(5%);
2. Add suffix "D" for 0-10V dimming, and "A" for 3 in 1 dimming.

INPUT

PARAMETER	CONDITIONS	MIN	TYP	MAX	UNITS
Input voltage		90		305	Vac
Input frequency		47		63	Hz
Input current	Full load, Vin=230Vac		0.21		A
Inrush current	Cold start, Vin=230Vac			35	A
Power factor(PF)	Full load, Vin=110Vac Full load, Vin=220Vac		0.99 0.92		
Leakage current	Vin=230Vac, 50Hz		0.75		mA
Surge voltage	L-N L, N-FG		3 3		KV KV

OUTPUT

PARAMETER	CONDITIONS	MIN	TYP	MAX	UNITS
Output current accuracy			5		%
Line regulation	Vin from 100Vac to 277Vac			1	%
Load regulation	Vout from min. to max.			3	%
Output current overshoot	Turning on			10	%
Turn-on delay time	Cold start, power on		1		S
Ripple (Refer to below note)	Default Model Low Ripple(with suffix "R")		50%Io 5%Io		mAp-p mAp-p
THD	Output load≥50%			20	%

NOTE: The values are measured at 20MHz of bandwidth by using a 12" twisted pair-wire terminated with 0.1uF & 47uF parallel capacitor under ambient temperature 25°C at rated input voltage and rated load.

Protection

Short circuit	In hiccup mode, it will recover automatically after fault condition is removed
Over voltage	110-150% Vout In hiccup mode, it will recover automatically after fault condition is removed
Over current	In hiccup mode, it will recover automatically after fault condition is removed
Over temperature	In hiccup mode, it will recover automatically after fault condition is removed

Environment

PARAMETER	CONDITIONS	MIN	TYP	MAX	UNITS
Ambient operating temperature	Startup at rated voltage	-35		+70	°C
Operating relative humidity	Non condensing	10		95	%
Storage temperature	Humidity 5 ~ 100% RH	-40		+85	°C
Maximum case temperature	Hot-spot on case			+90	°C
MTBF	Full load, 220Vac input, 25°C ambient temperature	300			Khrs
Waterproof rating	IP67				
Dimension(LxWxH)	193.0 x 43.5 x 34.5mm				
Weight	455g				

Safety/EMC

Safety	Design refer to UL8750, UL935, UL1012, UL1310 Class 2, EN61347, EN61347-2-13
EMC	Compliance to EN55015, FCC Part 15 Class B, EN61000-3-2, EN61000-3-3, EN61000-4-2, 3, 4, 6, 8, 11, EN61547

NOTE: Unless otherwise specified, all the above parameters are measured at ambient temperature of 25°C and Vin=100Vac to 277Vac.

Mechanical

No Dimming

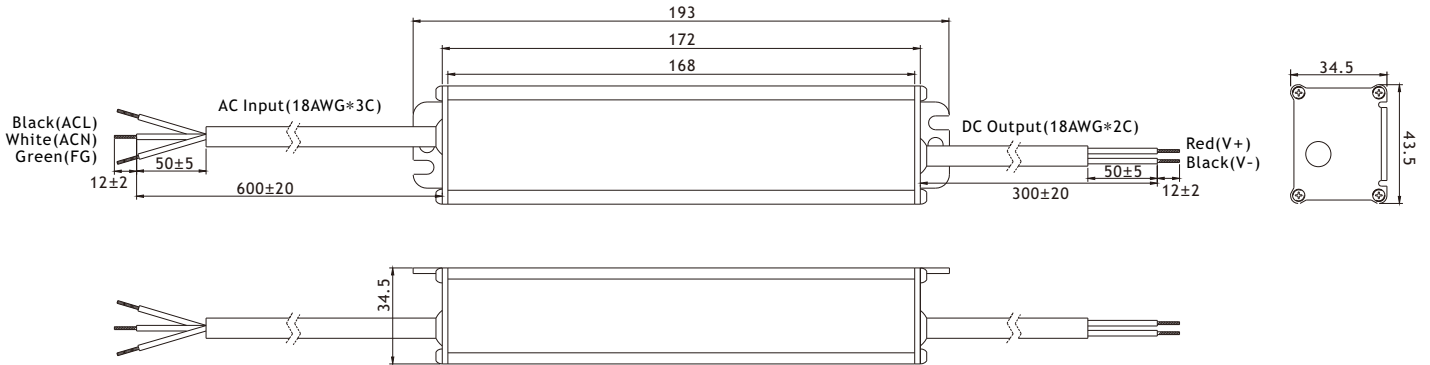

0-10V Dimming/3 in 1 Dimming

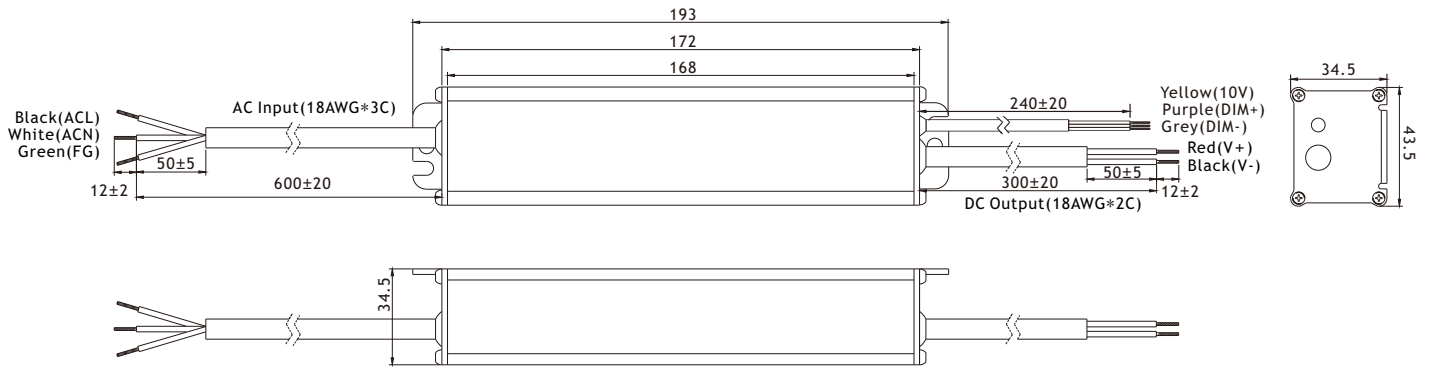

Electrical Curve

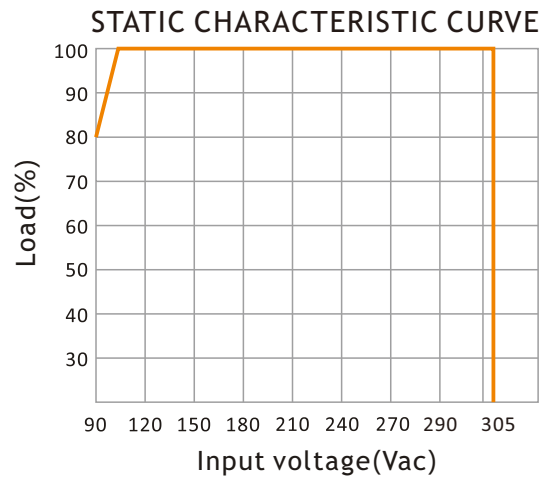
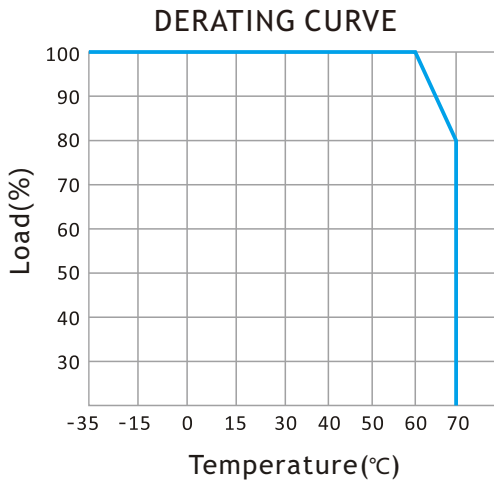

Dimming Function

0-10V Dimming

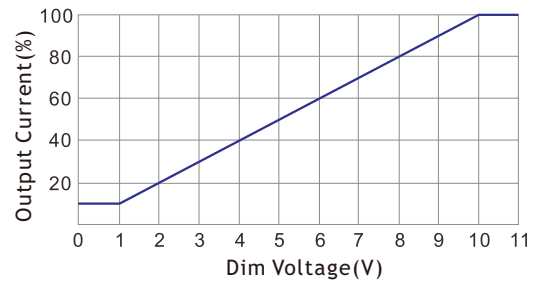
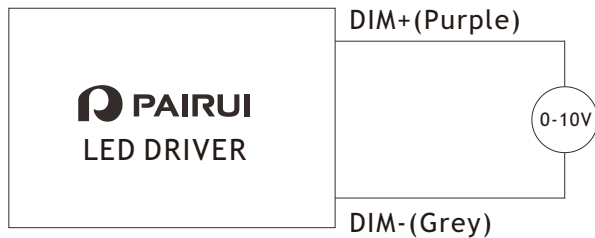

External Resistor Dimming

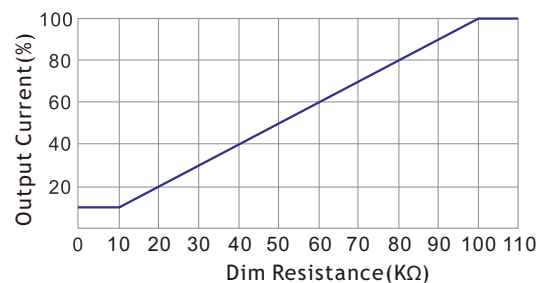
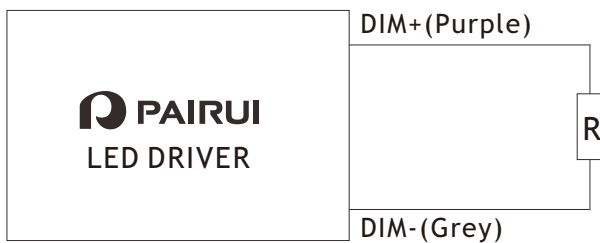

Dimming Function

PWM Dimming

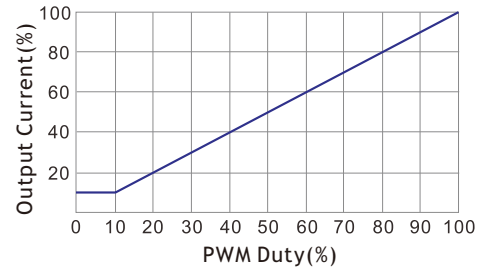
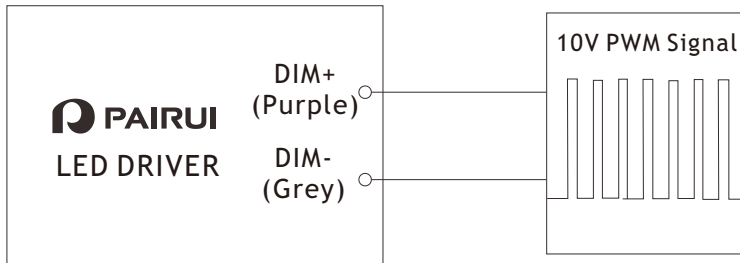

Package

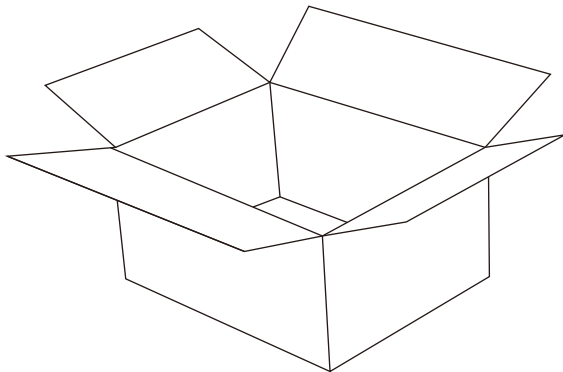



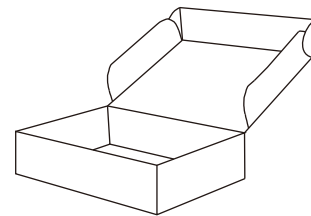

Outer Carton
L 620 x W 260 x H 185mm









Inner Box
L 245 x W 102.5 x H 46mm







SERIES	QTY/BOX	QTY/CARTON	NET WEIGHT	GROSS WEIGHT	VOLUME
LGU-40C	1 piece	18 boxes	8.2kg/carton	10kg/carton	0.03CBM/carton

Labelling

INPUT <ul style="list-style-type: none"> • ACL (BLK) • ACN (WHT) • ⊕ (GRN) 	 LGU40-C700 LED POWER SUPPLY INPUT: 100-277VAC, 50/60Hz OUTPUT: 700mA, 40-57VDC MADE IN CHINA	• ta 70°C • tc 90°C   IP67 	OUTPUT DC+ (RED) • DC- (BLK) •

INPUT <ul style="list-style-type: none"> • ACL (BLK) • ACN (WHT) • ⊕ (GRN) 	 LGU40-C700D LED POWER SUPPLY INPUT: 100-277VAC, 50/60Hz OUTPUT: 700mA, 40-57VDC MADE IN CHINA (0-10V Dimming)	• ta 70°C • tc 90°C   	OUTPUT 10V (YEL) • DIM+ (PPL) • DIM- (GRY) • DC+ (RED) • DC- (BLK) •

INPUT <ul style="list-style-type: none"> • ACL (BLK) • ACN (WHT) • ⊕ (GRN) 	 LGU40-C700A LED POWER SUPPLY INPUT: 100-277VAC, 50/60Hz OUTPUT: 700mA, 40-57VDC MADE IN CHINA (3 in 1 Dimming)	• ta 70°C • tc 90°C IP67  	OUTPUT 10V (YEL) • DIM+ (PPL) • DIM- (GRY) • DC+ (RED) • DC- (BLK) •

Symbol	Description
	Short-circuit-proof with safety insulation
	Independent Operation
IP67	Type of protection(IP67 for indoor and outdoor use)
	UL & CUL Mark
	RoHS Mark
	CE Mark
	3C Mark