



2016-V1.0-1227

# Specifications

---

**Constant Current LED Power Supplies**

**LXU-10C Series, 10W**

**PAIRUI ELECTRONICS**

No. 545 Museum Road  
Yangzhou, Jiangsu  
China 225009

Tel: 86 (514) 8279 1592

Fax: 86 (514) 8769 3159

**2016**

# LED Power Supplies for Indoor Use

## LXU-10C SERIES, 10WATT, IP20 RATING

### Features

- 3 Year Warranty
- Universal Input Voltage Range: 100~240Vac
- Constant Current Output Mode
- Waterproof Rating IP20
- Built-in Active Power Factor Correction
- Class II Power, no FG
- Short Circuit, and Over Temperature Protections



### Applications

- ✓ Panel Light
- ✓ Down Light
- ✓ Recessed Light
- ✓ Cabinet Light
- ✓ Other Indoor used Lights

### Electrical

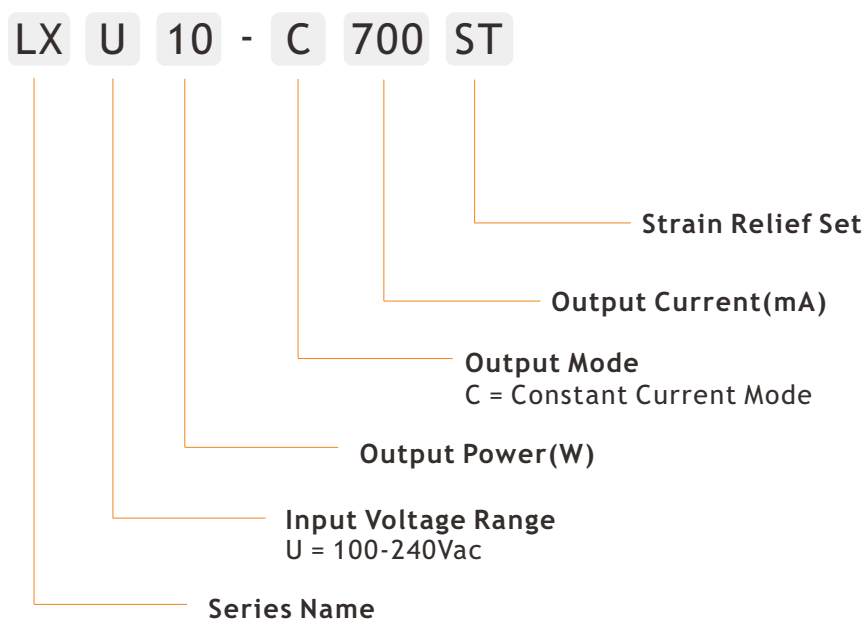

## Electrical

Part Number	Nominal Input Voltage	Output Current Output Voltage	No Load Output Voltage	Ripple	Efficiency	Certificate
LXU10-C240	100-240VAC	240mA(30-42V)	50V	50%	90%	CE
LXU10-C350	100-240VAC	350mA(20-29V)	34V	50%	90%	CE
LXU10-C500	100-240VAC	500mA(14-20V)	26V	50%	88%	CE
LXU10-C700	100-240VAC	700mA(11-15V)	18V	50%	86%	CE

NOTE: Other output models are may available on request.

INPUT

PARAMETER	CONDITIONS	MIN	TYP	MAX	UNITS
Input frequency		47		63	Hz
Input current	Full load, Vin=110Vac Full load, Vin=220Vac		0.13 0.06		A A
Inrush current	Cold start, Vin=230Vac			15	A
Power factor(PF)	Full load, Vin=110Vac Full load, Vin=220Vac		0.94 0.92		
Surge voltage	L-N		2		KV

**OUTPUT**

PARAMETER	CONDITIONS	MIN	TYP	MAX	UNITS
Output current accuracy			±5		%
Line regulation	Vin from 100Vac to 240Vac		3		%
Load regulation	Vout from min. to max.		3		%
Output current overshoot	Turning on			10	%
Turn-on delay time	Cold start, power on		1000		ms
Ripple	Please refer to below measuring method		50%Io		mAp-p
THD	Output load≥60%			20	%

NOTE: The values are measured at 20MHz of bandwidth by using a 12'' twisted pair-wire terminated with 0.1uF & 47uF parallel capacitor under ambient temperature 25°C at rated input voltage and rated load.

**Protection**

Short circuit	In hiccup mode, it will recover automatically after fault condition is removed
Over temperature	120°C-160°C It will recover automatically after the temperature goes down

## Environment

PARAMETER	CONDITIONS	MIN	TYP	MAX	UNITS
Ambient operating temperature	Startup at rated voltage	-25		+70	°C
Operating relative humidity	Non condensing	20		90	%
Storage temperature	Humidity 10 ~ 95% RH	-40		+80	°C
Maximum case temperature	Hot-spot on case			+75	°C
MTBF	Full load, 220Vac input, 25°C ambient temperature	230			Khrs
Waterproof rating	IP20				
Dimension(LxWxH)	70.0 x 43.0 x 30.0mm				
Weight	130g				

## Safety/EMC

Safety	Design refer to EN61347-1, EN61347-2-13
EMC	Compliance to EN55015, FCC Part 15 Class B, EN61000-3-2, EN61000-3-3, EN61000-4-2, 3, 4, 5, 6, 8, 11, EN61547

NOTE: Unless otherwise specified, all the above parameters are measured at ambient temperature of 25°C and Vin=100Vac to 240Vac.

### Mechanical

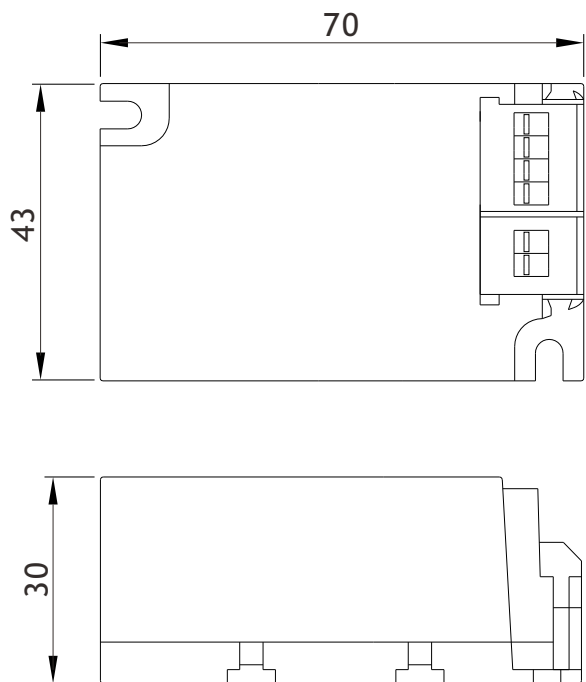

Unit: mm

### Electrical Curve

