



2016-V1.0-1227

Specifications

Constant Current LED Power Supplies

LT Series, 10~25W

PAIRUI ELECTRONICS

No. 545 Museum Road
Yangzhou, Jiangsu
China 225009

Tel: 86 (514) 8279 1592

Fax: 86 (514) 8769 3159

2016

LED Power Supplies for Indoor Use

LT SERIES, 10~25WATT, IP20 RATING

Features

- 3 Year Warranty
- High Input Voltage Range: 220~240Vac(198~264Vac)
- Constant Current Output Mode
- Waterproof Rating IP20
- Built-in Active Power Factor Correction
- Short Circuit, and Over Temperature Protections
- Low Ripple, High Power Density, High Conversion Efficiency



Applications

- ✓ Panel Light
- ✓ Down Light
- ✓ Recessed Light
- ✓ Cabinet Light
- ✓ Other Indoor used Lights

Electrical

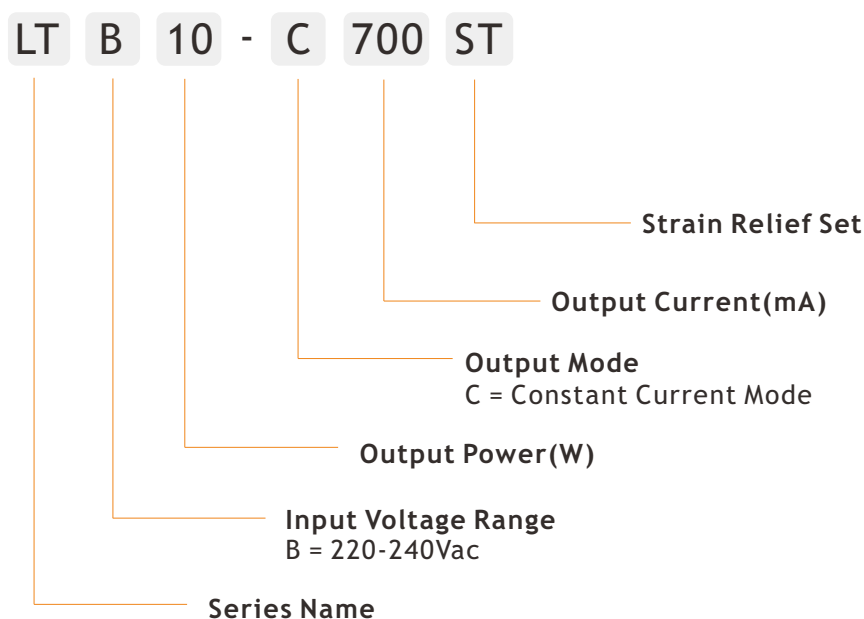

Electrical

Part Number	Nominal Input Voltage	Output Current Output Voltage	Ripple	Efficiency	Certificate
10W					
LTB10-C240	220-240VAC	240mA(25-42V)	≤5%	89%	CE
LTB10-C350	220-240VAC	350mA(17-29V)	≤5%	88%	CE
LTB10-C500	220-240VAC	500mA(12-20V)	≤5%	87%	CE
LTB10-C700	220-240VAC	700mA(9-15V)	≤5%	87%	CE
12W					
LTB12-C240	220-240VAC	240mA(30-50V)	≤5%	89%	CE
LTB12-C350	220-240VAC	350mA(20-34V)	≤5%	89%	CE
LTB12-C500	220-240VAC	500mA(15-24V)	≤5%	88%	CE
LTB12-C700	220-240VAC	700mA(11-17V)	≤5%	88%	CE
15W					
LTB15-C240	220-240VAC	240mA(37-62V)	≤5%	89%	CE
LTB15-C350	220-240VAC	350mA(26-42V)	≤5%	89%	CE
LTB15-C500	220-240VAC	500mA(18-30V)	≤5%	88%	CE
LTB15-C700	220-240VAC	700mA(13-21V)	≤5%	88%	CE

NOTE: Other output models are may available on request.

Electrical

Part Number	Nominal Input Voltage	Output Current Output Voltage	Ripple	Efficiency	Certificate
20W					
LTB20-C350	220-240VAC	350mA(40-57V)	≤5%	90%	CE
LTB20-C500	220-240VAC	500mA(28-40V)	≤5%	89%	CE
LTB20-C700	220-240VAC	700mA(20-29V)	≤5%	89%	CE
LTB20-C1050	220-240VAC	1050mA(13-19V)	≤5%	88%	CE
25W					
LTB25-C350	220-240VAC	350mA(50-71V)	≤5%	90%	CE
LTB25-C500	220-240VAC	500mA(35-50V)	≤5%	90%	CE
LTB25-C700	220-240VAC	700mA(25-35V)	≤5%	89%	CE
LTB25-C1050	220-240VAC	1050mA(16-23V)	≤5%	88%	CE

NOTE: Other output models are may available on request.

INPUT

PARAMETER	CONDITIONS	MIN	TYP	MAX	UNITS
Input frequency		47		63	Hz
Input current	Full load, Vin=220Vac, 10W		0.1		A
	Full load, Vin=220Vac, 12W		0.12		A
	Full load, Vin=220Vac, 15W		0.15		A
	Full load, Vin=220Vac, 20W		0.17		A
	Full load, Vin=220Vac, 25W		0.19		A
Inrush current	Cold start, Vin=230Vac			15	A
Power factor(PF)	Full load, Vin=220Vac		0.92		
Surge voltage	L-N		2		KV

OUTPUT

PARAMETER	CONDITIONS	MIN	TYP	MAX	UNITS
Output current accuracy			±5		%
Line regulation	Vin from 220Vac to 240Vac		3		%
Load regulation	Vout from min. to max.		3		%
Output current overshoot	Turning on			10	%
Turn-on delay time	Cold start, power on		1000		ms
Ripple	Please refer to below measuring method		5%Io		mAp-p
THD	Full load, Vin=220Vac			20	%

NOTE: The values are measured at 20MHz of bandwidth by using a 12" twisted pair-wire terminated with 0.1uF & 47uF parallel capacitor under ambient temperature 25°C at rated input voltage and rated load.

Protection

Short circuit	In hiccup mode, it will recover automatically after fault condition is removed
Over temperature	120°C-160°C It will recover automatically after the temperature goes down

Environment

PARAMETER	CONDITIONS	MIN	TYP	MAX	UNITS
Ambient operating temperature	Startup at rated voltage	-25		+70	°C
Operating relative humidity	Non condensing	20		90	%
Storage temperature	Humidity 10 ~ 95% RH	-40		+80	°C
Maximum case temperature	Hot-spot on case			+75	°C
MTBF	Full load, 220Vac input, 25°C ambient temperature	230			Khrs
Waterproof rating	IP20				
Dimension(LxWxH)	70.0 x 43.0 x 30.0mm				
Weight	130g				

Safety/EMC

Safety	Design refer to EN61347-1, EN61347-2-13
EMC	Compliance to EN55015, FCC Part 15 Class B, EN61000-3-2, EN61000-3-3, EN61000-4-2, 3, 4, 5, 6, 8, 11, EN61547

NOTE: Unless otherwise specified, all the above parameters are measured at ambient temperature of 25°C and Vin=220Vac to 240Vac.

Mechanical

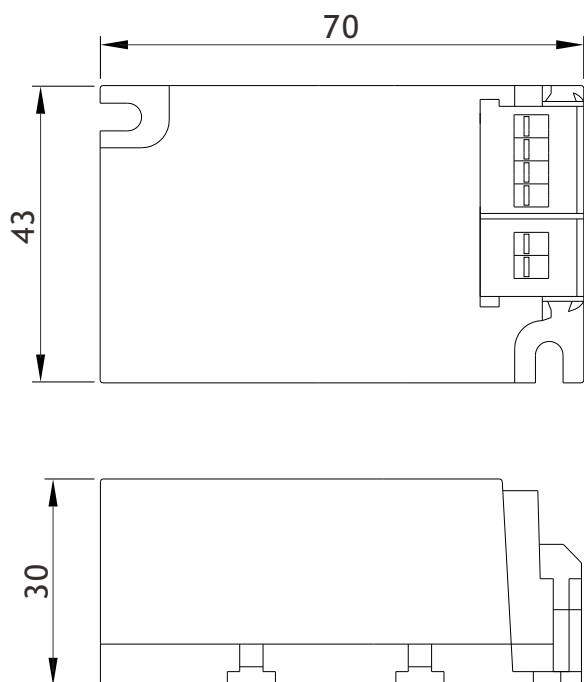

Unit: mm

Electrical Curve

