



2017-V1.0-0111

Specifications

**NFC Programmable LED Power Supplies
LGHU-120CV Series, 120W**

PAIRUI ELECTRONICS

No. 545 Museum Road
Yangzhou, Jiangsu
China 225009

Tel: 86 (514) 8279 1592

Fax: 86 (514) 8769 3159

2017

NFC Programmable LED Power Supplies

LGHU-120CV SERIES, 120WATT, IP67 RATING

Features

- 5 Year Warranty
- Universal Input Voltage Range: 90~305Vac
- NFC Programmable Technology without driver power-on
- Constant Power Programmable Design
- Dim to Off Option
- All Round Protections: Short Circuit, Over Voltage, Over Current, Over Temperature
- Optional Dimming(0-10V, PWM, Timer)



Applications

- ✓ Street Light
- ✓ Tunnel Light
- ✓ Flood Light
- ✓ Other Light Fixtures for Outdoor Use

Electrical

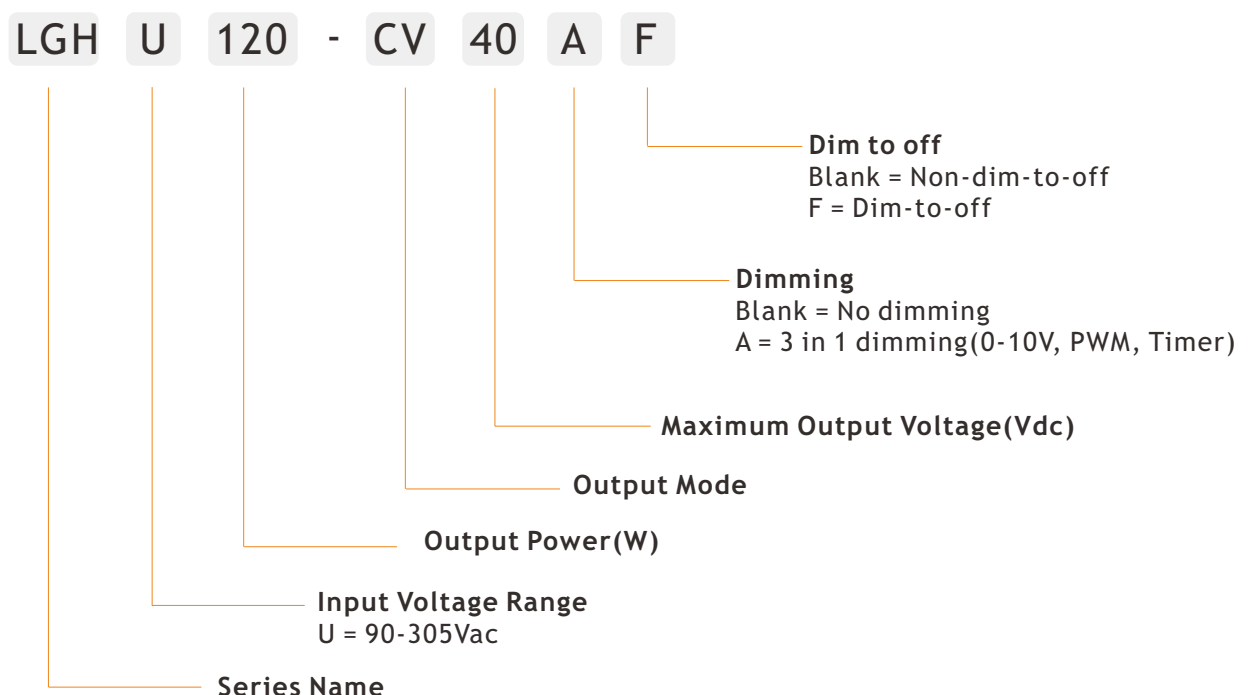

Electrical

Part Number	Nominal Input Voltage	Constant Power Output Voltage Range	Programmable Constant Current Region	Working Voltage Range	Certificate
LGHU120-CV36	100-277VAC	24-36V	2000-5000mA	14.4-36V	CE, UL
LGHU120-CV48	100-277VAC	36-48V	1330-3330mA	21.6-48V	CE, UL
LGHU120-CV80	100-277VAC	48-80V	1000-2500mA	28.8-80V	CE, UL
LGHU120-CV140	100-277VAC	80-140V	600-1500mA	48-140V	CE, UL
LGHU120-CV274	100-277VAC	140-274V	340-860mA	84-274V	CE, UL

NOTE: Other output models are may available on request.

INPUT

PARAMETER	CONDITIONS	MIN	TYP	MAX	UNITS
Input voltage		90		305	Vac
Input frequency		47		63	Hz
Input current	Full load, Vin=115Vac Full load, Vin=230Vac		1.17 0.57		A A
Inrush current	Cold start, Vin=230Vac			65	A
Power factor(PF)	Full load, Vin=115Vac Full load, Vin=230Vac		0.99 0.97		
Efficiency	Full load, Vin=115Vac Full load, Vin=230Vac		87 88		% %
Surge voltage	L-N L, N-FG		4 6		KV KV

OUTPUT

PARAMETER	CONDITIONS	MIN	TYP	MAX	UNITS
Line regulation	Vin from 100Vac to 277Vac		±0.3		%
Load regulation	Vout from min. to max.		±0.6		%
Ripple			2%Vo		mVp-p
THD	Output load≥50%			20	%

Protection

Short circuit	In hiccup mode, it will recover automatically after fault condition is removed
Over voltage	130% Vout, in hiccup mode, it will recover automatically after fault condition is removed
Over current	95~108%, constant current limiting, it will recover automatically after fault condition is removed
Over temperature	In hiccup mode, it will recover automatically after fault condition is removed

Environment

PARAMETER	CONDITIONS	MIN	TYP	MAX	UNITS
Ambient operating temperature	Startup at rated voltage (Derating required)	-35		+70	°C
Operating relative humidity	Non condensing	10		100	%
Storage temperature	Humidity 5 ~ 100% RH	-40		+85	°C
MTBF	Full load, 220Vac input, 25°C ambient temperature(MIL-HDBK-217)	200			Khrs
Temperature coefficient	±0.05%/°C(0~50°C)				
Vibration	10~500Hz, 5G 12min. / 1 cycle, period for 72 min. each along X,Y,Z axes				
Waterproof rating	IP67				
Dimension(LxWxH)	207.0 x 70.0 x 37.0mm				
Weight	760g				

Safety/EMC

Safety	Design refer to UL8750, UL935, CSA-C22.2 No.107.1, EN61347-1, EN61347-2-13
Withstand Voltage	I/P-O/P: 3.75KVAC
Isolation resistance	I/P-O/P: 100M ohms/500VDC/25°C/70%RH
EMC Emission	Compliance to EN55015, EN61000-3-2 Class C(≥60% load), EN61000-3-3
EMC Immunity	Compliance to EN61000-4-2, 3, 4, 5, 6, 8, 11, EN61547, EN55024

NOTE: Unless otherwise specified, all the above parameters are measured at ambient temperature of 25°C and Vin=100Vac to 277Vac.

Mechanical

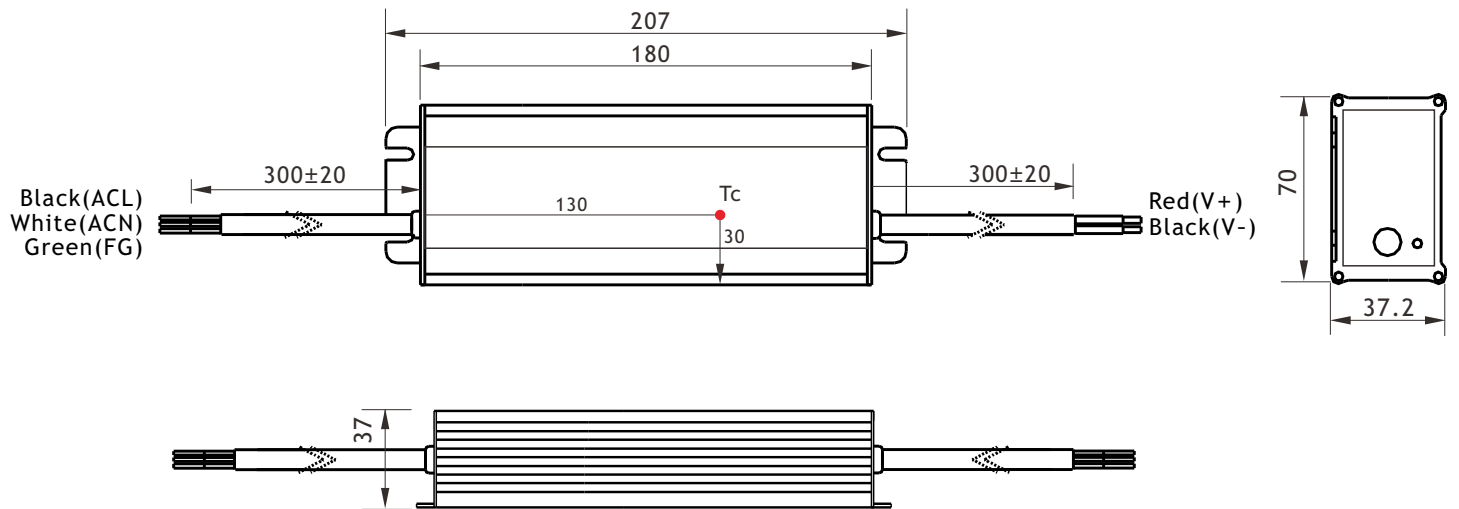

Electrical Curve

DERATING CURVE

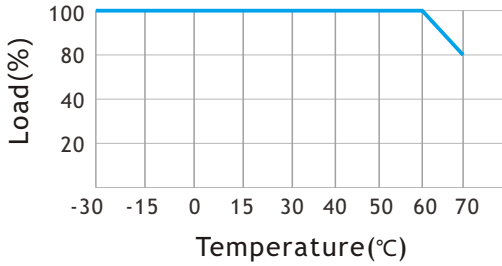

STATIC CHARACTERISTIC CURVE

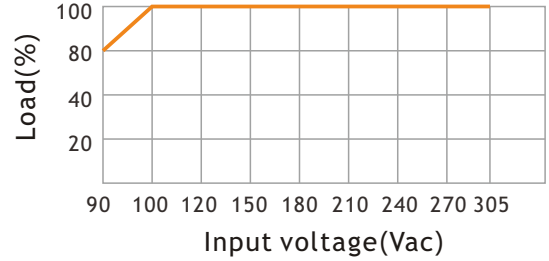

PF vs Load

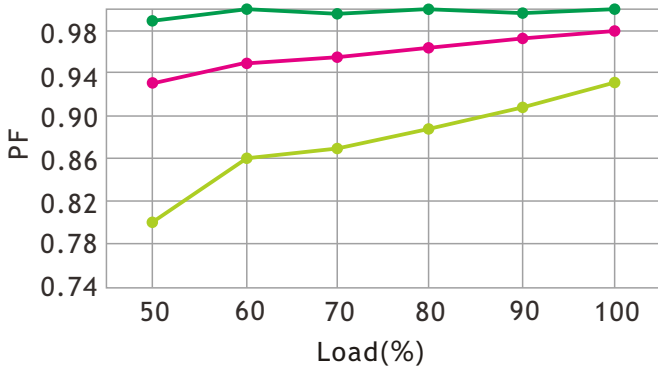

THD vs Load

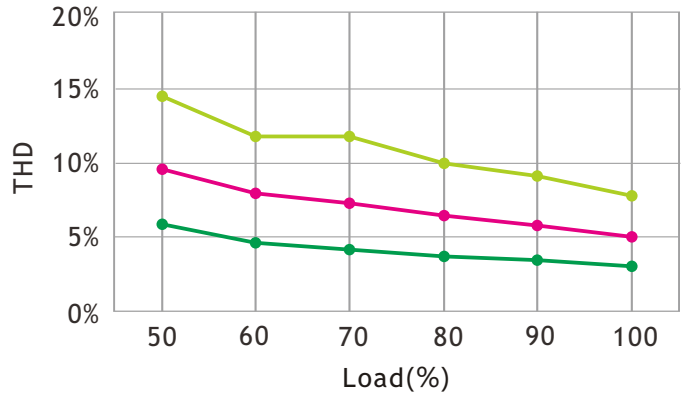

Efficiency vs Load

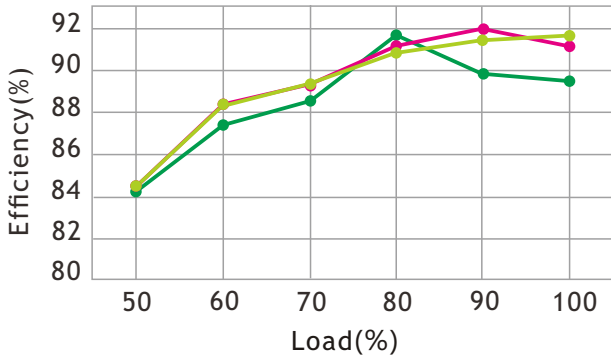

- 120V Input
- 220V Input
- 277V Input

Lifetime vs Tc

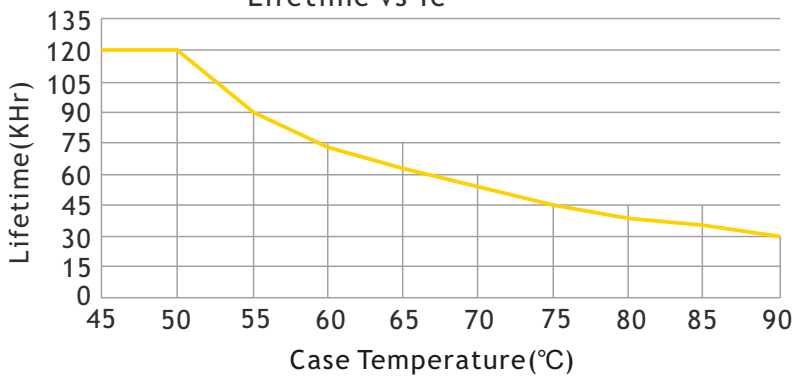

Dimming Function

0-10V Dimming & PWM Dimming

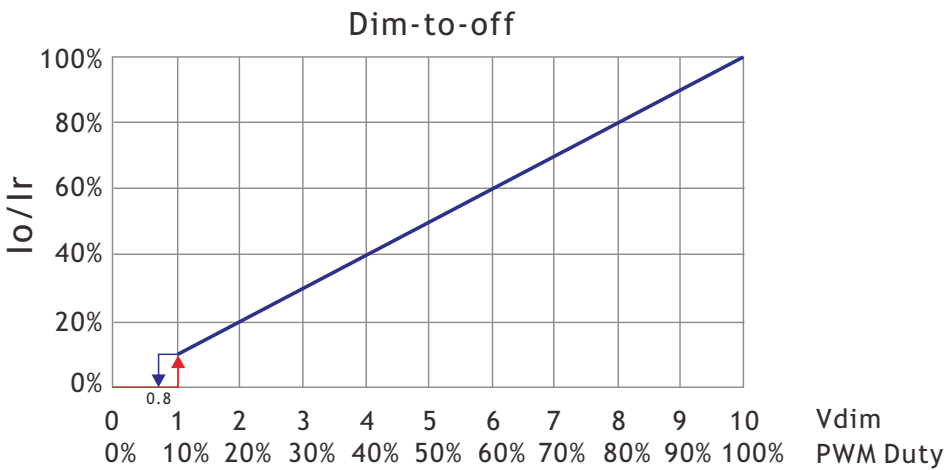
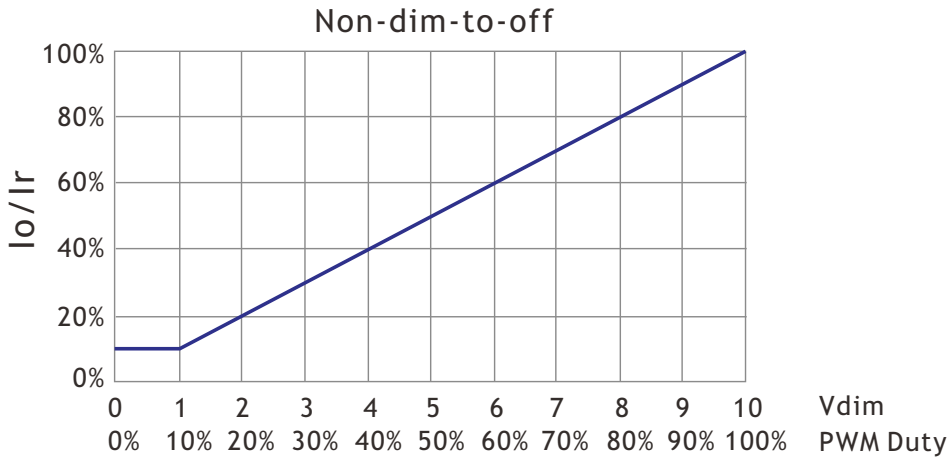

GND	Gery	Input Source Current	0-10mA
Dimming wire 0-10V & PWM	Purple	10V AUX Source Current	20mA
10V AUX	Yellow	PWM Frequency Range	0.5~3KHz
Input Dimming Voltage	0-10V	PWM High Level	10V

- NOTE: 1. I_o is actual output current, and I_r is rated current without dimming control;
 2. For the driver to operate properly, the load voltage must be in the working voltage range;
 3. The driver has dim-to-off option that can be programmed by the NFC controller;
 4. Maximum input voltage at dimming wire is 12V;
 5. AUX wire is only for source, it cannot connect to other voltage source.

Dimming Function

Timer Dimming

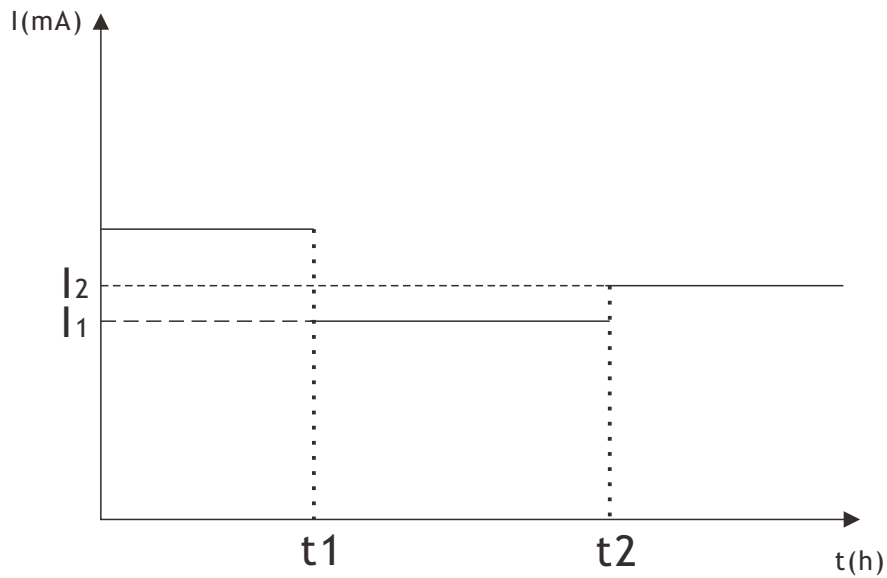

- NOTE: 1. The dimming time can be programmed by the NFC controller;
 2. The time of t_1 and t_2 can be set by the NFC controller;
 3. The value of I_1 and I_2 can be set by the NFC controller;
 4. Current changes from I_1 to I_2 need a few minutes.

NFC Controller

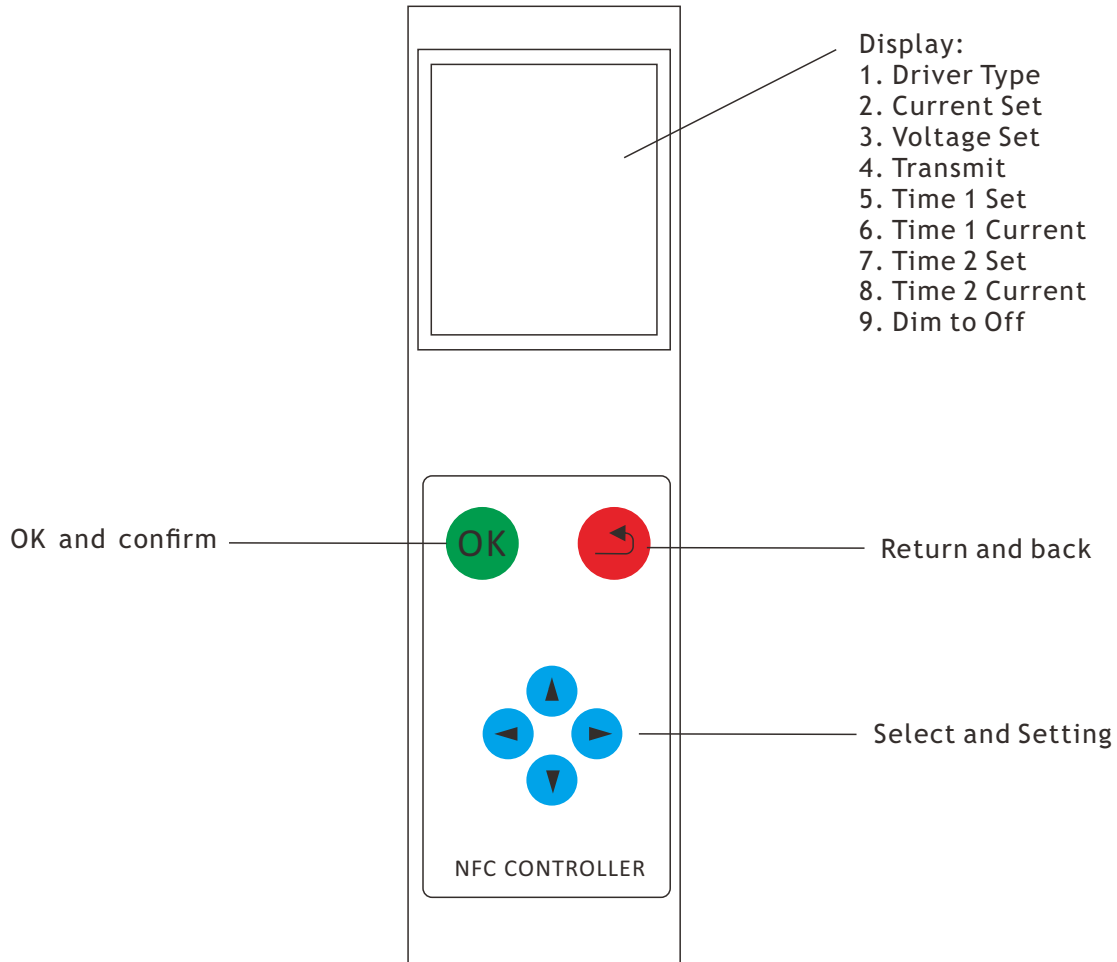

Note: 1. The NFC controller can modulate the output current and output voltage;
 2. The NFC dimming is a way of non-contact process, so it's much safer than the traditional ones;
 3. Power devices can be programmed without driver power-on.



